

CW 750 V1

Compact Height

BMW B2 4005	FORD W-DX35-6204	PSA E24.54.815.G
MB B8 3180 220 000 004		
VW 39D 997		

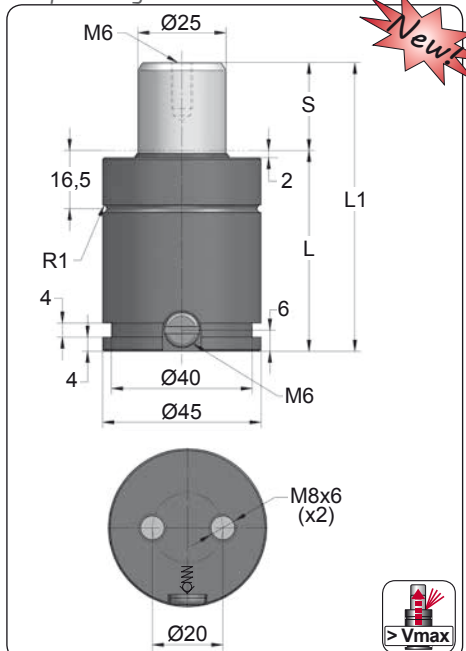

ORDER	S (mm)	L1 ±0,25 (mm)	L (mm)	Kg.
CW 750 010 V1	10	52	42	0.37
CW 750 013 V1	13	58	45	0.39
CW 750 016 V1	16	64	48	0.41
CW 750 019 V1	19	70	51	0.43
CW 750 025 V1	25	82	57	0.47
CW 750 032 V1	32	96	64	0.51
CW 750 038 V1	38	108	70	0.55
CW 750 050 V1	50	132	82	0.62
CW 750 063 V1	63	158	95	0.70
CW 750 075 V1	75	182	107	0.78
CW 750 080 V1	80	192	112	0.81
CW 750 100 V1	100	232	132	0.93
CW 750 125 V1	125	282	157	1.09

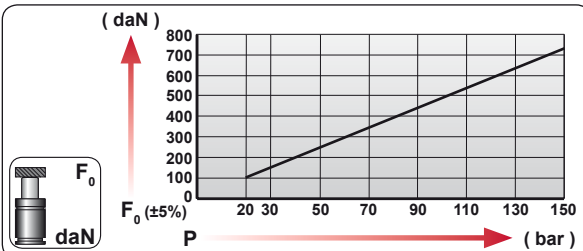

CODE				
	bar	psi	daN	daN
CW 750 050 V1	150	2175	740	1215
CW-H 750 050 V1	0	0	---	---

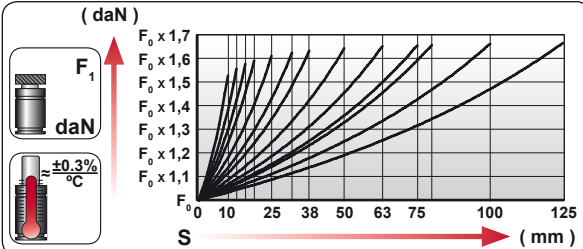

	ENG ORDER DEU BESTELLUNG FRA COMMANDE ITA ORDINE ESP PEDIDO POR PEDIDO		
		daN	mm
		CW 750	50
		CW 750 050 V1	

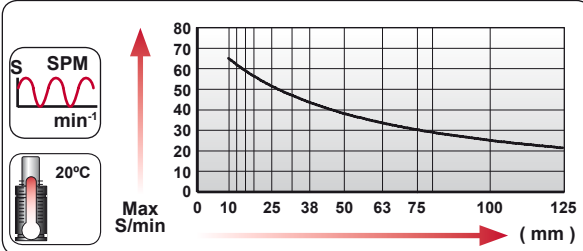

N ₂	S _{max} < 90%	V _{max} 1,6 m/s	P _{min} (20°C)	P _{max} (20°C)	T _{min}	T _{max}	600 CP-

bar	psi	bar	psi	°C	°F	°C	°F
20	290	150	2175	0	32	80	176

MODEL	×	CW 750 KZ 750	AS 700	CK 750 FD 500	CM 600 CD 700	APF 500	CPH 1250	×	
SERIES	MINI	COMPACT HEIGHT	THREADED	LOW PROFILE	HEAVY DUTY	ISO	HEAVY LOAD	POWER COMPACT STROKE	

CW

KRM6 **BK**

CWC

DRM8

TNRR

9RM8

MCRR

7RM8

TFRR

SKK

SGS

CODE	CW 750 050 V1	KIT S-XXXXXXX KIT C-XXXXXXX	A14-045	06 CG 2-Q
ENG ORDER	GAS SPRING	REPAIR KIT	FLANGE	CHARGING ADAPTER
DEU BESTELLUNG	GASDRUCKFEDER	ERSATZTEILSATZ	FLANSCH	LADEADAPTER
FRA COMMANDE	RESSORT À GAZ	KIT DE RÉPARATION	BRIDE	RACCORD DE CHARGE
ITA ORDINE	CILINDRO AD AZOTO	KIT DI MANUTENZIONE	FLANGE	ADATTATORE DI CARICO
ESP PEDIDO	RESORTE DE GAS	KIT DE REPARACION	BRIDA	ADAPTADOR DE CARGA
POR PEDIDO	CILINDRO DE GAS	KIT DE MANUTENÇÃO	FLANGE	ADAPTADOR DE CARGA

CWC 750 V2 MOUNTS

Compact Height

AZOL
GAS

A14-045

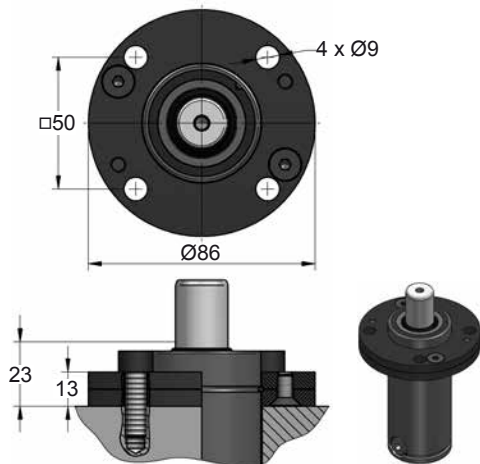

A34-045

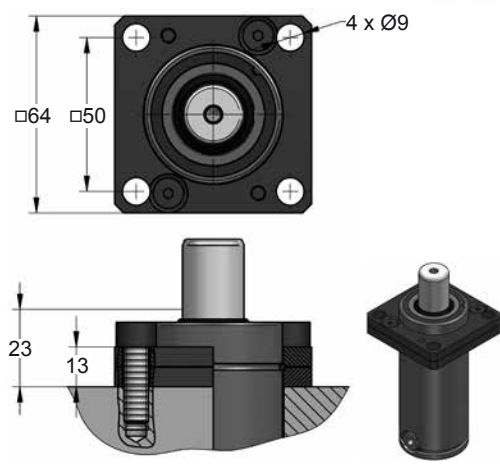

B36-045

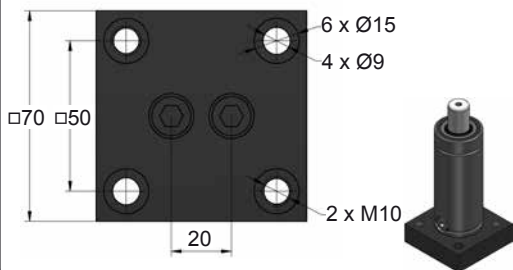
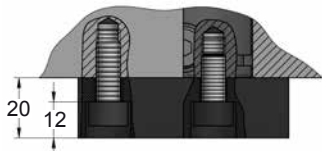

B41-045

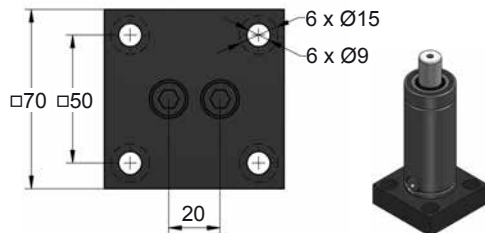
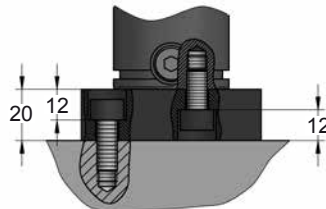

SEAL
KIT S-XXXXXXX

CARTRIDGE
KIT C-XXXXXXX

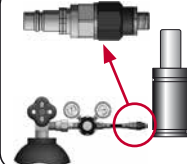
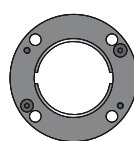

CODE	CWC 750 050 V2	KIT S-XXXXXXX KIT C-XXXXXXX	A14-045	18 CG 1-Q
ENG	ORDER	GAS SPRING	FLANGE	CHARGING ADAPTER
DEU	BESTELLUNG	GASDRUCKFEDER	FLANSCHEN	LADEADAPTER
FRA	COMMANDE	RESSORT À GAZ	BRIDE	RACCORD DE CHARGE
ITA	ORDINE	CILINDRO AD AZOTO	FLANGE	ADATTATORE DI CARICO
ESP	PEDIDO	RESORTE DE GAS	BRIDA	ADAPTADOR DE CARGA
POR	PEDIDO	CILINDRO DE GÁS	FLANGE	ADAPTADOR DE CARGA

CWC 750 V2 MOUNTS

Compact Height

C05-045

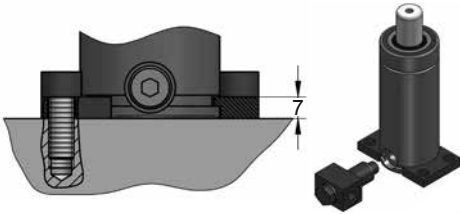
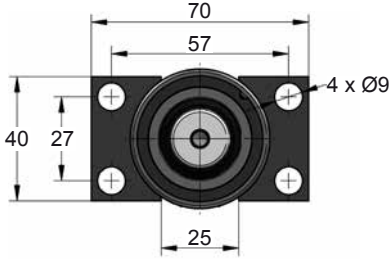

C20-045

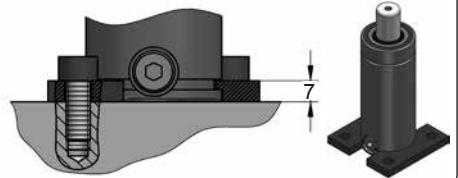
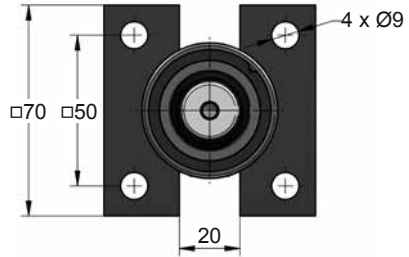

D02-045

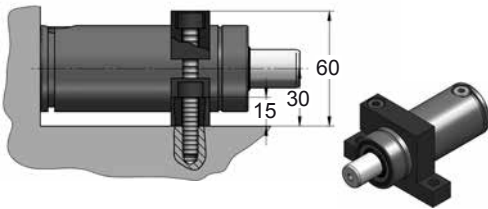
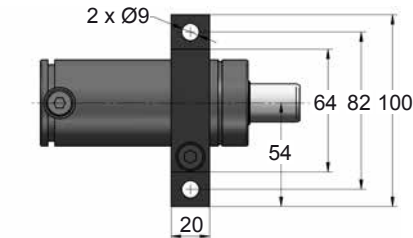

D67-045

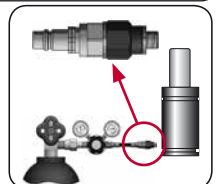
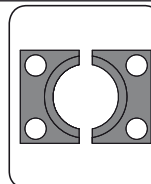
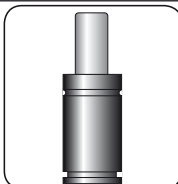
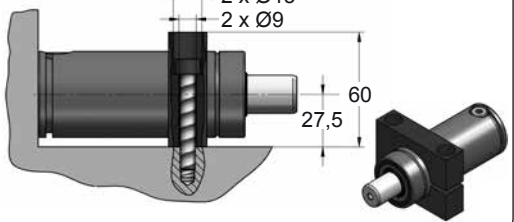
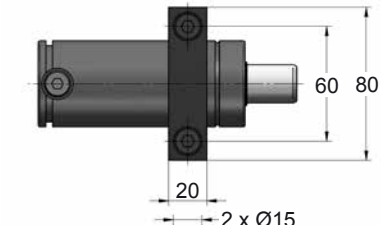

CODE	CWC 750 050 V2	KIT S-XXXXXXX KIT C-XXXXXXX	C05-045	18 CG 1-Q
ENG	ORDER	GAS SPRING	FLANGE	CHARGING ADAPTER
DEU	BESTELLUNG	GASDRUCKFEDER	FLANSCHEN	LADEADAPTER
FRA	COMMANDE	RESSORT À GAZ	BRIDE	RACCORD DE CHARGE
ITA	ORDINE	CILINDRO AD AZOTO	FLANGE	ADATTATORE DI CARICO
ESP	PEDIDO	RESORTE DE GAS	BRIDA	ADAPTADOR DE CARGA
POR	PEDIDO	CILINDRO DE GÁS	FLANGE	ADAPTADOR DE CARGA